



# Moravia

YACHTING



## AMARYLLIS

Builder	Abeking & Rasmussen
Year/Refit	2011
LOA	78.43m (257' 4")
Beam	12.4m (40' 7")
Draft	3.45m (11' 3")
GT	2,108
Cabins	6
Guests	12
Speed	17 knots
Price	€89,000,000 Ex VAT



A Hill Robinson Company









Main Salon





Forward Salon





Piano Lounge





Sky Lounge





Dining





Master Stateroom Office





Master Stateroom





Master En Suite - His





Master En Suite - Hers





Master Private Deck





VIP Stateroom





VIP En Suite





Double Stateroom





En Suite - Guest





Double Stateroom





Double Stateroom





Twin Stateroom





Elevator & Staircase





Bridge Deck - Dining





Sun Deck Forward





Upper Deck





Jacuzzi Pool





Beach Club





Massage Area



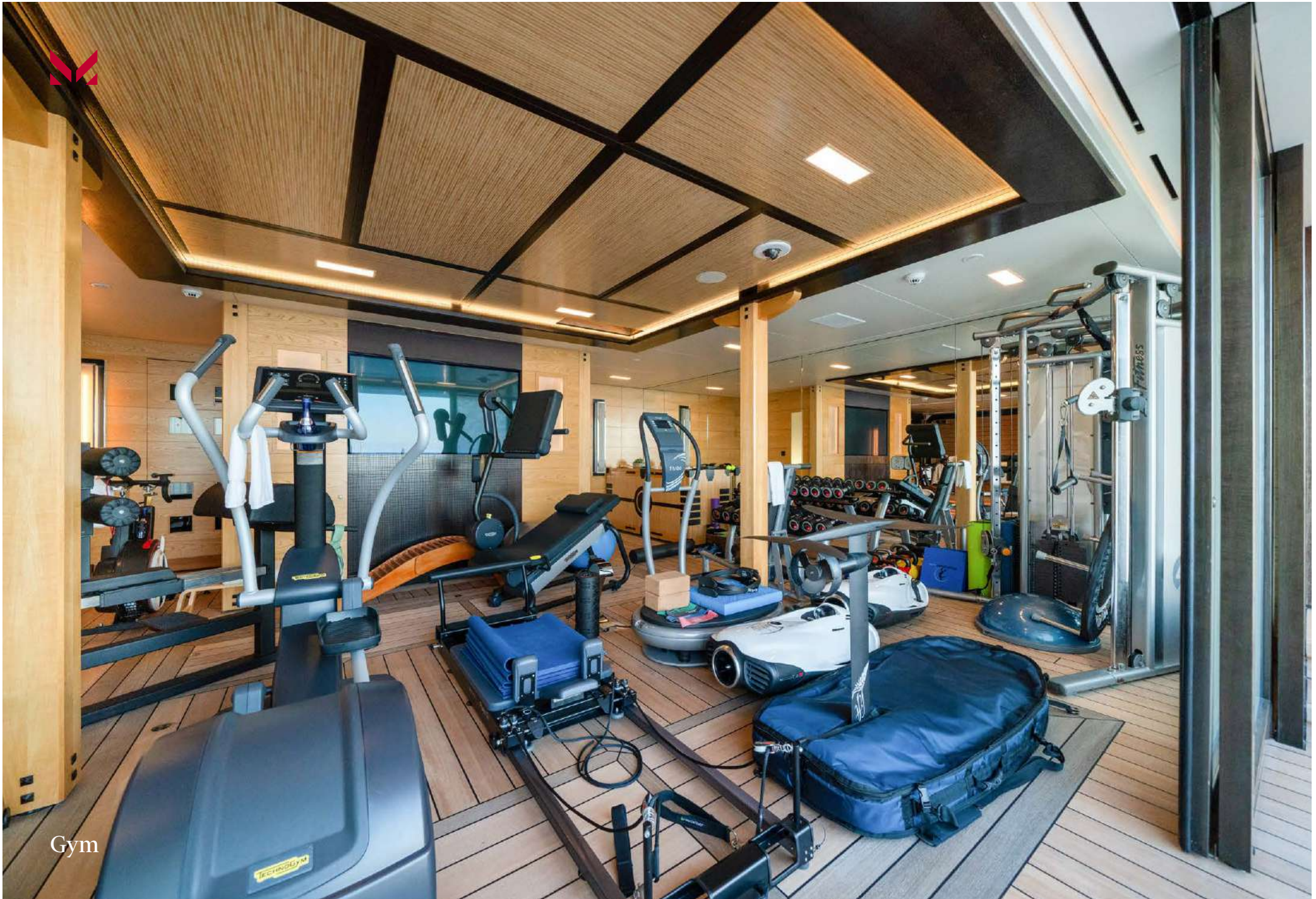

Gym





Spa





Sauna and Steam Room





Graf Tender





Toys



## MAIN SPECIFICATIONS

Type	Full Displacement Motor Yacht
Flag	Cayman Islands
Dimensions	
	<b>Length</b> 78.43m (257' 4")
	<b>Beam</b> 12.4m (40' 7")
	<b>Draft</b> 3.45m (11' 3")
Gross Tonnage	2,108
Year Built	2011
Builder	Abeking & Rasmussen
Naval Architect	Abeking & Rasmussen
Interior Design	Reymond Langton
Exterior Design	Reymond Langton
Hull Construction	Steel
Superstructure	Aluminium
Maximum Speed	17 knots
Cruising Speed	14 knots
Fuel Capacity	224,000 litres
Water Capacity	87,400 litres
Fuel Consumption	550 litres per hour
Range	4,039 nm @ 14.0 knots

## CERTIFICATIONS

Port of Registry	George Town
Class / MCA	Lloyds Register +100A1 SSC Yacht, Mono, EP, G6, +LMC, UMS / Commercial / MCA / ISM / ISPS

## ACCOMMODATION

Number of Cabins	1 Master, 1 VIP, 3 Double, 1 Twin
Total Guests	12
Total Crew	23

## MACHINERY

Main Engines	2 x 2,000 HP Caterpillar 3516B DITA-SCAC, Series II Total Output: 2984kW
--------------	--

Engine Hours 31st Aug 2025	Current total running hours	Next basic service due at	Hours at last full overhaul	Next overhaul due	
				Top End	Full
Main engine - Port	9,841	10,629	-	10,000	30,000
Main engine - Starboard	9,859	10,648	-	10,000	30,000
Generator 1	20,827	20,881	20,375	25,375	30,375
Generator 2	25,682	25,785	25,070	30,070	35,070
Generator 3	20,559	20,638	20,150	25,150	30,150

## AUXILIARY MACHINERY & ELECTRICAL SYSTEM

Main Generators	3 x Caterpillar C18. Output 412 kW continuous
Emergency Generator	1 x Caterpillar C9 Output 144kW continuous
Shore Power	2 x Atlas Marine System transformers Output: 230/400 Vac 215A 3Ph
Batteries	24V system

## TANK CAPACITIES (approximate)

Fuel	187,000 litres
Fresh Water	87,400 litres
Watermakers	2x HEM Duplex H40/5600 (Max production output app.44000 Lt/day)
Clean Lub Oil	3,300 litres
Dirty Lub Oil	5,500 litres
Grey Water	27,200 litres holding capacity
Black Water	DVZ biological sewage treatment plant 11,100 litres/day

## ANCILLARY EQUIPMENT

Steering System	Hydro-Control Maschinenbau GmbH, HC 15610- 41964
Rudder Angle Indicators	2 x 35°
Bow Thruster	Schottel tunnel thruster STT 170 T fixed pitch 250 kW x1
Stern Thruster	Schottel pump jet SPJ 57 RD 220 kW x1
Stabilisers	2 pairs Quantum QC-1800-MI, zero speed at anchor system
Fuel Oil Separator	1x Alpha Laval MAS 104B-14/24
Oil/Water Separator	1x B&V Industries GmbH turbulo mechanical phase breaker
Bilge/Fire pump	3x Allweiler NI 40-250/01
Boilers	Wesco Navy 4153040 / 2007
Sewage Treatment	DVZ SKA-60 "Biomaster
WC's	Evac 910
Air conditioning	Draws Marine GmbH
Ventilation	D5 x air handlers, forced air ventilation



## SAFETY & SECURITY EQUIPMENT

### Safety

- 4 x 20 Man RFD SOLAS Pack A liferafts
- 2 x 10 Man RFD Surviva MK IV SOLAS Pack A liferafts
- 1 x Mcmurdo EPIRB
- 2 x Sailor type 2 SARTS
- 46 x SOLAS Kon Tiki Royal Foam lifejackets
- 30 x SOLAS approved Crewsaver inflatable lifejackets
- 36 x SOLAS Securmar inflatable lifejackets
- 10 x SOLAS approved foam child lifejackets
- 10 x Large Crewsaver adult immersion suits
- 10 x xtra large Crewsaver adult immersion suits
- 20 x Universal Crewsaver adult immersion suits
- 5 x Crewsaver child immersion suits
- 2 x Lifebuoys with Comet light and smoke float
- 2 x Lifebuoys with lights
- 2 x Lifebuoys with lines
- 2 x Lifebuoys without smoke, light, or line
- 4 x Pains Wessex's line throwing apparatus
- 12 x Comet red parachute flares
- 12 x Comet red handheld flares
- 6 x Comet white handheld flares
- 3 x GMDSS Sailor SP3520 handheld radios

### Medical

- 1 x Para-Guard Excel rescue stretcher
- 1 x Laerdal Bax Strap spinal board
- 6 x Medaire first responder kits
- Full MCA Medaire medical kit including:

- Dressings kit
- Emergency fluid Infusion kit
- Paediatric kit
- Fractures pack
- Medicines Pack 1 x Phillips Heart Start defibrillator
- 2 x Medaire burn kits
- 1 x Invacare Platinum 9 oxygen generator
- 1 x Yacht Lifeline oxygen pack
- 4 x Medaire emergency crash packs

### Fire Fighting

- 1 x MiniMax fixed sprinkler system throughout
- Mini Max Fixed Co2 extinguishing system engine room, Genset boxes and galley uptake
- 1x 50 litres foam extinguisher
- 14 x Total 9 litres AFFF extinguishers
- 13 x Total 6kg dry powder extinguishers
- 14 x Total 5kg CO2 extinguishers
- 1 x Class F extinguisher for cooking oil
- 40 x Draeger Parat C smoke hoods
- 7 x Sabre Elsa EEBD's
- 5 x Sabre Sigma BA sets
- 5 x sets of fire suits in bags
- 10 x fibreglass BA bottles
- 27 x fire hoses
- 27 x fire hose nozzles
- 7 x fire blankets
- 1 x foam applicator
- 2 x 20 litres AFFF drums

### Alarms

- ASI Monitoring and UMS alarm system

### Security

- Thrane and Thrane TT3000 SSAS
- 1 x Ocean View mast mounted thermal imaging, low light and std camera
- 1 x Axis 241Q//241S video server for CCTV with 13 security cameras
- IR beam system covering main and upper decks
- Palm Vein scanner entry system at gangway and crew door
- 3 x touch screen interfaces for monitoring and control
- External and technical space CCTV cameras Panasonic CCTV recorder
- Artwork monitoring
- Auto crew call through DECT phone network

## COMMUNICATION EQUIPMENT

### The yacht is GMDSS compliant

<b>Inmarsat "C"</b>	Thrane & Thrane TT 3000 Mini C with TT 3606E terminal
<b>EPIRB</b>	Sailor SE406 II satellite EPIRB Raytheon Anschutz MF/HF radiotelephone type CU5100
<b>VHF Radiotelephones</b>	Sailor C4900 2 x Raytheon Anschutz RT 5022 3 x Sailor SP3250 VHF GMDSS
<b>Telephone</b>	Siemens Hi Path 3000
<b>UHF Communications</b>	Motorola DR 3000 UHF repeater



## NAVIGATION EQUIPMENT

<b>Magnetic Compass</b>	Cassens & Plath Type II Ser. A401126
<b>Gyro Compass</b>	2 x Anschutz standard 22 gyro compass
<b>Automatic Pilot</b>	Raytheon Anschutz autopilot 2025
<b>E.M. Log</b>	Skipper EML 24 electromagnetic log
<b>Echo Sounder</b>	Raytheon Anschutz GDS 101
<b>Radar</b>	2 x Raytheon NSC 25/34 chart radars with 21" Hatteland screens
<b>Chart Plotter</b>	Raytheon NSC ECDIS Pathfinder fully compliant and type approved ECDIS
<b>GPS</b>	2 x SAAB R4 navigation systems
<b>Navtex</b>	Furuno NX 700A/3
<b>Wind Sensor</b>	Lambrecht Quatro Met (1642) wind sensor
<b>AIS</b>	SAAB R4 AIS class transponder system

## DECK EQUIPMENT

<b>Anchor Windlass</b>	2 x Steen 23-9-14 vertical windlass
<b>Aft warping capstans</b>	2 x Steen 59-9-10 vertical capstan
<b>Passerelle</b>	<ul style="list-style-type: none"> <li>- 1 x Aljo hydraulic stern gangway with 7m reach</li> <li>- Self-supported 200kg max. Pier supported 200kg/m<sup>2</sup></li> <li>- 1 x Yacht Tec hydraulic side access gangway</li> <li>- 1 x Marquipt sea stair side gangway</li> </ul>
<b>Awning</b>	<ul style="list-style-type: none"> <li>3 on sundeck</li> <li>2 on bridge deck</li> </ul>

## AUDIO/VISUAL ENTERTAINMENT SYSTEMS

### Main Salon

Crestron/iPad total room control interface with stew call? 65" Plasma HD TV, 5.1 Bowers & Wilkins Audio, Blu-ray/DVD/CD player, Crestron iPod interface, Gaming console system interface, Kaleidescape movie/music access, Satellite TV package.

### Piano Lounge

Crestron/iPad total room control interface with stew call, 65" Plasma HD TV, Schimmel self-playing grand piano, 5.1 Bowers & Wilkins Audio, Karaoke system, Blu-ray/DVD/CD player, Crestron iPod interface, Gaming console system interface, Kaleidescape movie/music access, Satellite TV package

### Gym/Beach Club

Crestron/iPad total room control interface with stew call, 65" plasma HD TV, 5.1 Bowers & Wilkins audio, Blu-ray/DVD/CD player, Crestron iPod interface, Gaming console system interface, Kaleidescape movie/music access, System links with spa, sauna, steam room, and swim platform, Satellite TV package.

### Owners Cabin

Crestron/iPad total room control interface with stew call, 42" plasma HD TV, 4.2 Bowers & Wilkins Audio, Sennheiser wireless headphones, Blu-ray/DVD/CD player, Crestron iPod interface, Gaming console system interface, Kaleidescape movie/music access, System links with office, bathrooms, dressing rooms and exterior deck, Satellite TV package.

### Guest Cabins

Crestron/iPad total room control interface with stew call, 50" plasma HD TV, 5.1 Bowers & Wilkins audio, Blu-ray/DVD/CD player, Crestron iPod interface, Gaming console system interface Kaleidescape movie/music access, System links with bathroom, Satellite TV package.

### Captain's Cabin

- Crestron/iPad total room control interface, 37" LCD HD TV, 5.1 Bowers & Wilkins audio
- Blu-ray/DVD/CD player, Crestron iPod interface, Gaming console system interface
- Kaleidescape movie/music access, Satellite TV package

### Crew Cabin

2 x 16" LCD HD TV, Dual zone stereo speakers, iPod dock, DVD/CD player.

### Crewmess

- Crestron/iPad AV room control interface, 2 x 42" plasma HD TVs, 2 x 21" touchscreen Monitor CCTV/security interfaces, 5.1 Bowers & Wilkins audio, Blu-ray/DVD/CD player
- Crestron iPod interface, Gaming console system interface, Kaleidescape movie/music access
- Satellite TV package

### Laundry

42" plasma HD TV, DVD/CD player, Ceiling mounted Bowers & Wilkins audio, iPod dock.



**DOMESTIC EQUIPMENT**

---

**Main Galley**

- Goldstar 945 BE90 electric surface range (4 station)
- Goldstar 945 BE45 electric surface range (2 station)
- Goldstar 945 BIHF 90 electric induction range (4 station)
- Goldstar 945 BEF 2/45 electric fryer (2 basket)
- MKN Electric salamander grill - vario
- MKN conventional electric oven
- Rational self cooking centre (steam combi oven)
- 4 x Bonhoff refrigerated drawers
- Bonhoff heated cupboard
- 2 x Liebherr GKPv 6580 10C 001 refrigerator
- 1 x Liebherr GKPv 6580 15C 001 freezer
- Liebherr FKUV 1660 under counter refrigerator
- 2 x Miele professional G7586 dishwasher
- Broan trash compactor
- Multivac C200 vacuum packer
- Grant temperature controlled water bath
- Vorwerk Thermomix
- Pako Jet
- Cappigiani labo/8 12E ice cream maker

**Laundry**

- 2 x Miele professional 5100 10Kg washer
- 2 x Miele professional T6251 10Kg dryer
- 3 x Miele professional 6065 Plus 6.5Kg washer
- 3 x Miele professional PT 7136 Vario 6.5Kg dryer
- Miele professional HM 21 rotary iron
- Laurastar Magic - Steam Ironing system
- Laurastar G4 Evolution steam iron
- Singer Talent sewing machine

**Pantry****Main Deck Pantry**

- Liebherr FKUV 1660
- Under counter refrigerator
- Miele Professional G7586 dishwasher
- Cimballi M21 Junior coffee machine
- Panasonic NE-CI475 microwave
- Broan trash compactor
- Hoshizaki ice maker

**Bridge Deck Pantry**

- Liebherr FKUV 1660 under counter
- Liebherr FKS 3602 full height glazed door refrigerator

**Dry Storage**

- 2 x EuroCave S283 wine refrigerator full height

**Crew Mess**

- 2 x Liebherr FKUV 1660 under counter refrigerator
- Liebherr FKS 3602 full height glazed door refrigerator
- 2 x Miele professional G7586 dishwasher
- Panasonic NE-CI475 microwave
- Gemini CS220 Pro coffee maker
- Water Logic water filter/cooler

**Upper Deck**

- Liebherr GKPv 6580 15C 001 freezer
- Miele professional G7586 dishwasher
- EuroCave S283 wine refrigerator
- Hoshizaki ice maker
- Cimballi M21 junior coffee machine
- Juice Master Pro

**OTHER EQUIPMENT**

---

**Gym**

- Technogym Excite + treadmill
- Technogym Kinesis personal vision resistance trainer
- Technogym bench press station with long bar and weight plates (5kg-20kg)
- Life Fitness multigym station
- Precor AMT - adaptive motion trainer
- CM Club versa climber
- Fit Vibe vibration plate
- Waterrower series IV rowing machine
- Hand dumbbell weights - pairs - 2 Kg-20Kg

**Spa**

- Large sauna cabin
- Steam cabinet
- Plunge pool with cooling option
- Shower and WC



## TENDERS & WATER TOYS EQUIPMENT

---

### Tenders

- 1 x 9m Graf Ipanema built from mahogany with a Volvo Penta D6 370hp & duo prop stern drive
- 1 x 8.8m Pascoe Beachlander with Volvo Penta D6 370hp & duo prop stern drive
- 1 x X25 Master Craft ski and wakeboard boat with Indmar 5.7 litres Petrol V8 & prop and rudder.
- 1 x Ribo 420 SOLAS approved rescue boat with Yamaha 25hp outboard

### Watersports equipment

- 1 x Yamaha FZS 3 person jetski 1800cc supercharged
- 1 x Liteweight carbon fibre stand up jetski
- 1 x Hyperlite Murray Bio 142 wakeboard
- 1 x Hyperlite Franchise 138 wakeboard
- 1 x Hyperlite Eden 135 for ladies wakeboard
- 1 x Hyperlite Motive for juniors wakeboard
- 1 x Connelly F1 Single Ski with Enzo bindings
- 1 x Connelly Big Daddy single ski with Nova bindings
- 1 x Connelly Junior Super Sport waterskis
- 1 x Connelly Big O inflatable donut
- 1 x Connelly mega wing deluxe
- 1 x Connelly Eclipse combo waterskis
- 3 x Jetpilot impact jackets
- 2 x KGB impact jackets for ladies
- 14 x Jobe watersports buoyancy aids
- 10 x Jobe full steamer wetsuits
- 1 x Custom Water Slide

- Fishing equipment
- 3 x Shimano Speedmaster AX27M rods
- 3 x Shimano Saragosa 8000 spinning reels
- 1 x Shimano Tiagra 135A big game reel
- 1 x Shimano Tiagra 135 rod
- 1 x Alutecnos 80/135 rod
- 1 x Alutecnos Albacore 50W 2 speed game reel
- Full selection of lures for big and small game
- Full selection of fishing tackle

## WORKS LIST - REFIT AND MAINTENANCE HISTORY

---

### 2023

General annual maintenance, overhaul of 3 x generators

### 2022

Replacement of all carpets, localized teak replacement and sanding

### 2021-2022

2nd Special Survey, full hull repaint, overall deck cushion re-upholstery, new dining room chairs

### 2019-2020

Painting of the entire superstructure

### 2018

General annual maintenance, 4K 100" TV upgrade and new 4K Kaleidescape Player installed across the interior, anchor upgrade

### 2017

Annual maintenance at Pendennis

### 2016

1st Special Survey, repainting of hull



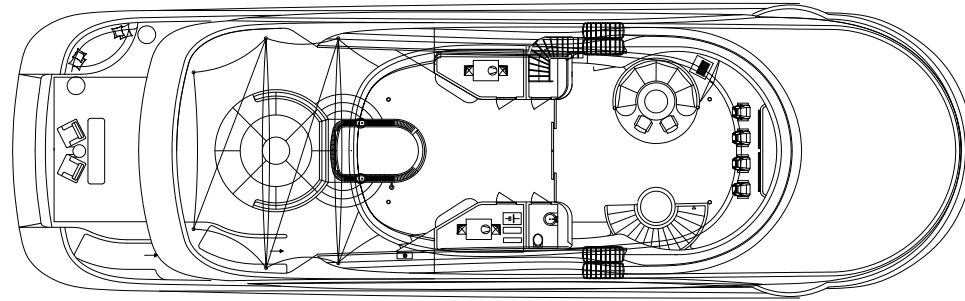

SUN DECK

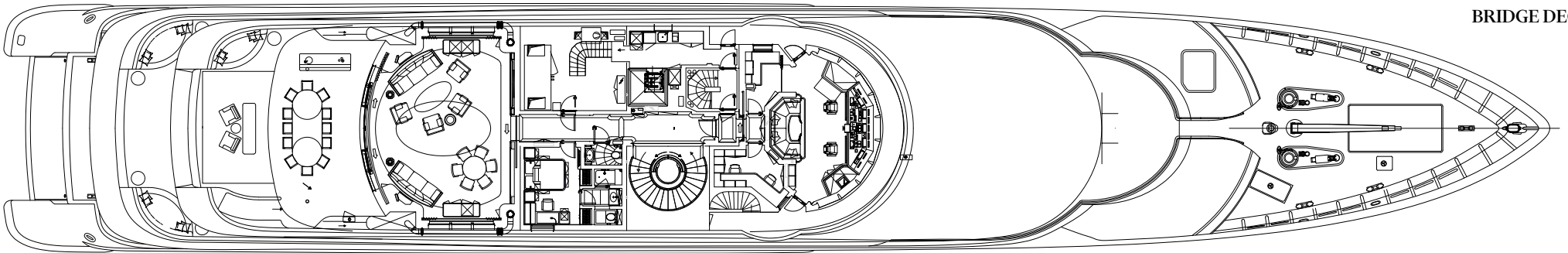

BRIDGE DECK

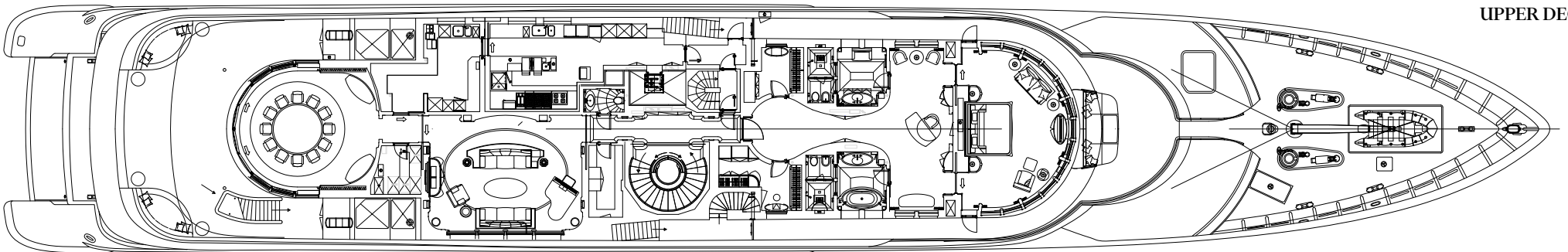

UPPER DECK



 General Arrangement

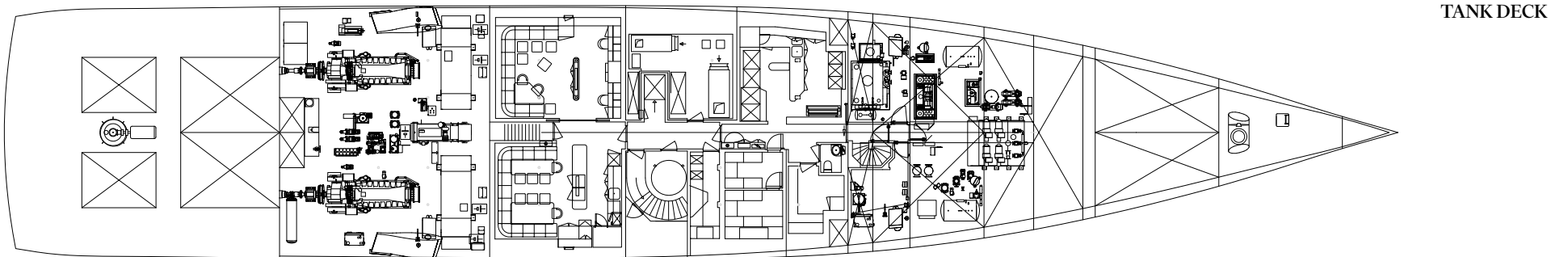
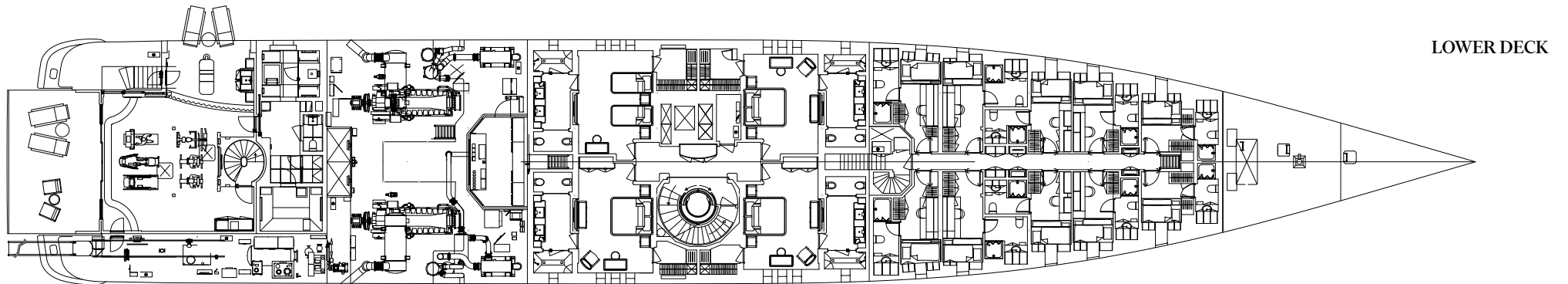
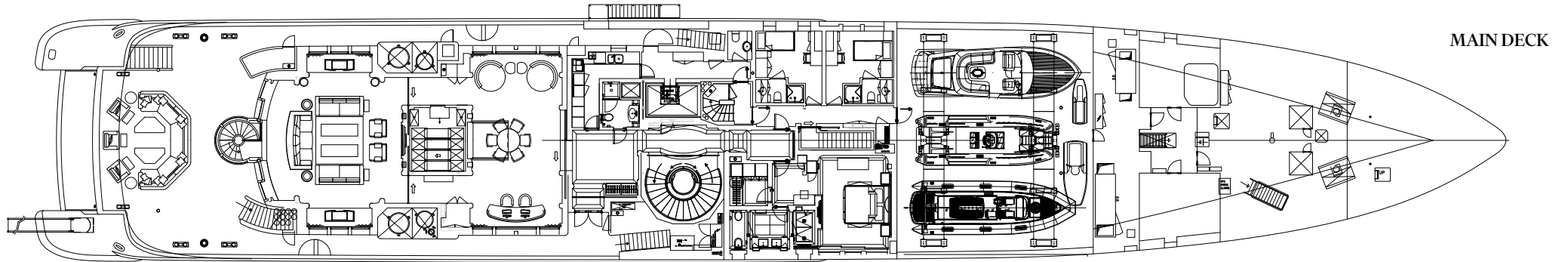





# Moravia

YACHTING



## Contact

**Adam Papadakis**

Head of Sales / Senior Sales Broker

+377 6 78 63 39 60 | [adam.papadakis@moraviayachting.mc](mailto:adam.papadakis@moraviayachting.mc)

[moraviayachting.mc](http://moraviayachting.mc)

While every effort has been made to ensure that the information contained in this document is accurate as at the date of production, the accuracy of such information cannot be guaranteed. Moravia Yachting gives no representation, warranty or undertaking, express or implied, as to: the accuracy, reliability, completeness or reasonableness of the information contained in this document; the condition of a featured yacht and/or its equipment; the seaworthiness of a featured yacht; or the suitability and/or availability of a featured yacht for purchase or charter. The fees, specifications, figures, images and comments included in this document are subject to change without notice. This document has been produced by Moravia Yachting at the request of the person identified on the front cover for discussion purposes only and is confidential. This document must not be copied or distributed to any third party, in whole or part, without Moravia Yachting's express written permission. Moravia Yachting hereby expressly excludes any liability howsoever arising in respect of any inaccuracies or errors in the information contained in this document, to the fullest extent permitted by law.